



0015e3[®] ECM High-Efficiency Circulator

Taco 0015e3[®] is a variable speed, high-efficiency, wet rotor circulator with an ECM permanent magnet motor. It is available in cast iron for closed loop hydronic heating, or stainless steel for open loop or domestic water applications. With 3 easy settings, the 0015e3 delivers performance, reliability and ease of installation that made the 00[®] famous.



Features & Benefits

The 0015e3[®] ECM circulator: Three settings. One reputation.



Use the Cast Iron 0015e3 with a Taco Switching Relay or Zone Valve Control



Use the Stainless Steel 0015e3 for open loop potable hot water systems with up to 1,000 feet of recirculation piping

- 18' Shut-off head, 16 gpm max flow
- Replaces all 3-speed hydronic circulators in its class
- High-efficiency ECM motor uses up to 85% less electricity
- **SureStart[®]** automatic unblocking and air purging mode
- **BIO Barrier[®]** protects pump from system contaminants (Cast Iron only)
- **Green Mode** active system monitoring and automatic power optimization
- Nut-grabber feature on flanges for easier fit-up
- Dual electrical knockouts, 6" stranded wire leads included for easy wiring
- Integral Flow Check (IFC[®]) included
- Double insulated — No ground wire required
- Whisper quiet operation
- Cast Iron models available with standard or universal flange
- Stainless Steel models available with universal flange or 1" union connection
 - Customizable 1/2" & 3/4" union fitting sets available in sweat, NPT or press (Sold Separately)

Multi-color LED showing operating mode and error code diagnostics



Orange LED:
Indicates 007e is running normally



SureStart[®] LED:
Indicates the innovative **SureStart[®]** automatic unblocking and air purge is active



Green Mode LED:
Indicates the 007e is running in **Green Mode** for power optimization

Replaces ALL 3-speed hydronic circulators in its class

Taco	Grundfos	Armstrong	Xylem/B&G	Wilco
005	UP15-10	Astro 225	ecocirc 19-16	Star S 16
006	UP15-42	Astro 230	NBF-22/NRF-22	Star S 21
007	UPS15-55	Astro 250	NBF-25/NRF-25	Stratos ECO 16
008	UPS15-58	Astro 20	NBF-9/NRF-9F/LW	
0015	Alpha 15-55	Astro 25	SSF-9U/LW	
0015 3-Speed	Alpha2 15-55	Astro 30		
007e		Astro 30-3		
		Astro 50-3		
		Compass H20-20		

Applications & Performance

Typical Applications for Closed Loop Hydronic Heating Systems

For zoning with circulators

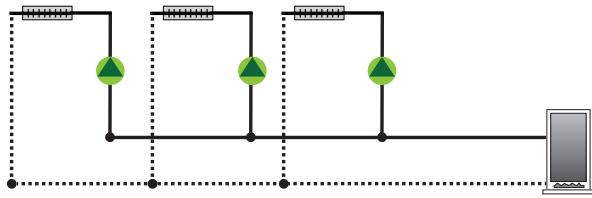

Across a series loop system using zone valves

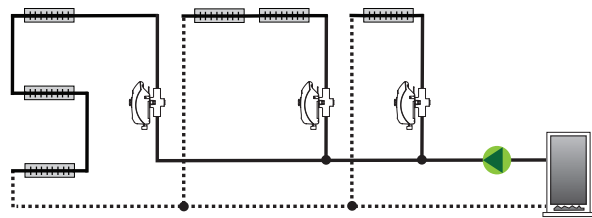

Typical Installation for Open Loop Hot Water Recirculation Systems

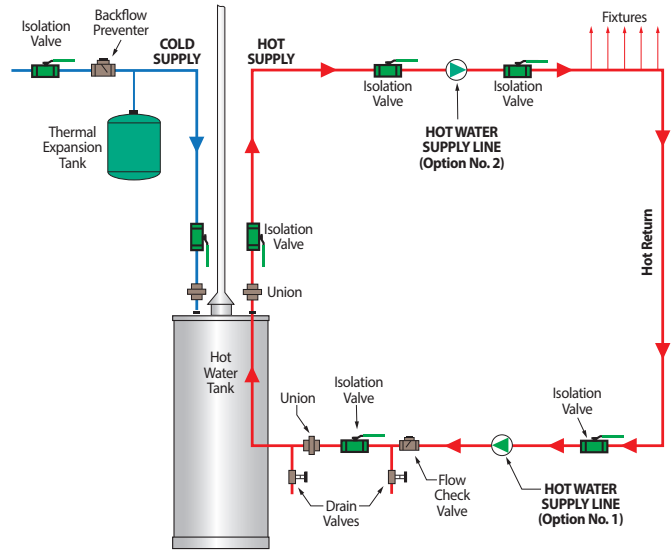

Performance Curves

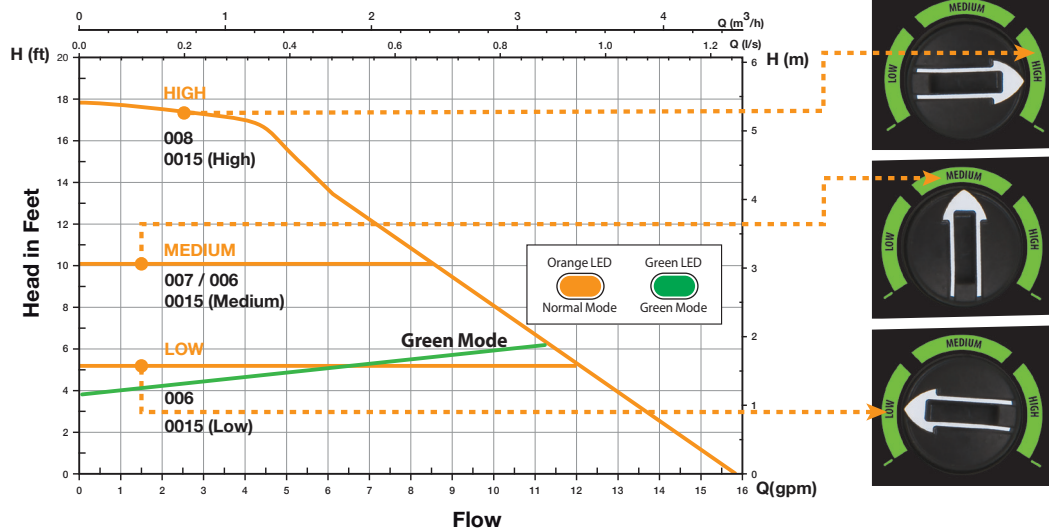

The 0015e3 circulator provides three constant pressure settings to match system requirements. Selection options are **LOW** (5 feet), **MEDIUM** (10 feet), or **HIGH** (18 feet). See chart above for the equivalent 00® model at each setting.

The 0015e3 performance curves are ideal for hydronic zoning to reduce velocity noise or banging of zone valves closing against high head pressure circulators.

Hydronic Heating Setting Selection Guide: Longest circuit in the system

LOW	=	85 ft. x 3/4" copper
MEDIUM	=	165 ft. x 3/4" copper
HIGH	=	245 ft. x 3/4" copper

Domestic Hot Water Selection Guide: Recirculation piping lengths

LOW	=	200 ft.
MEDIUM	=	500 ft.
HIGH	=	1,000 ft.

Submittal Data Information Taco 0015e3[®] ECM Circulators

Submittal Data #101-201
Supersedes: 03/05/21

Effective: 08/16/21

Specifications

- Max. Shut-off Head: 18 feet
- Max. Flow: 16 gpm
- Max. Operating Pressure:
 - Cast Iron: 125 psi (8.6 bar)
 - Stainless Steel: 150 psi (10 bar)
- Max. Water Temp: 230°F (110°C)
- Min. Water Temp: 36°F (2°C)
- Electrical specifications:
 - Voltage: 120V, 60 Hz
 - Single phase
 - Max. Operating Power: 44W
 - Max. AMP Rating: 0.54
- Cast iron casing suitable for closed loop systems only
- Stainless steel casing suitable for potable water or open systems
- Not suitable for chilled water
- Taco circulator pumps are for indoor use only
- Acceptable for use with water or maximum of 50% water/glycol solution

Materials of Construction:

Casing: Cast Iron or
Stainless Steel
Stator Housing: Composite
Cartridge: Composite
Impeller: Composite
Shaft: Ceramic
Bearings: Carbon
Thrust Bearing: Ceramic
O-Ring & Gaskets: EPDM



Certified to
NSF/ANSI 61 & 372

Stainless Steel
models only



Applications

The 0015e3 is a variable speed, high-efficiency wet rotor circulator with an ECM permanent magnet motor. Its ECM performance is equivalent to the Taco 0015 3-Speed circulator. It is ideal for hydronic systems zoned with circulators or zone valves or used on potable water systems for domestic water recirculation. The 0015e3 is not suitable for chilled water systems.

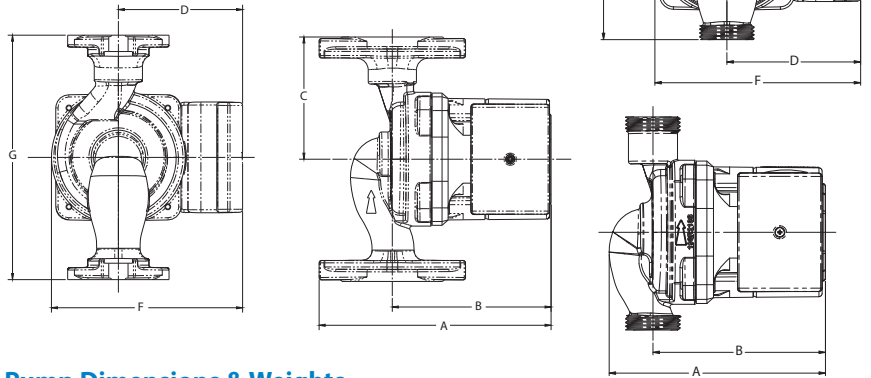

Pump Dimensions & Weights

Model Number	Connection Type	Casing	A		B		C		D		F		G		Ship Wt.	
			in.	mm	in.	mm	in.	mm	in.	mm	in.	mm	in.	mm	lbs.	Kg
0015e3-2F2	Standard	CI	6	152	4-1/8	104	3-3/16	80	3-1/4	82	5	126	6-3/8	161	5.8	2.6
0015e3-2F4	Universal	CI	6	152	4-1/8	104	3-3/16	80	3-1/4	82	5	126	6-3/8	161	6	3.7
0015e3-SF4	Universal	SS	6	152	4-1/8	104	3-3/16	80	3-1/4	82	5	126	6-3/8	161	5.5	2.5
0015e3-SU	Union	SS	5-1/6	131	4-1/8	104	3-3/16	80	3-1/4	82	5	126	5-1/8	130	4.6	2.1

Connection Types

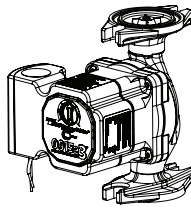

Cast Iron Standard Flange

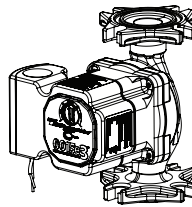

Cast Iron Universal Flange

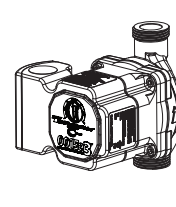

Stainless Steel Union

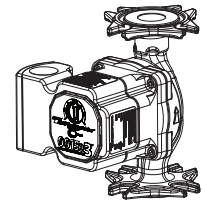

Stainless Steel Universal Flange

Electrical Data

Model	Volts	Hz	Ph	Max. Amps	Max. Watts	RPM
All Models	120	60	1	.54	44	1590-4830
Motor Type	ECM, Permanent Magnet, Thermally Protected					

HYDRAULIC INSTITUTE ENERGY RATING

Model #: 0015e WAIP: 0.071

CIRCULATOR PUMP CEI: 0.39 (ER 188)

ENERGY RATING

152 188

Most Consumptive RANGE Least Consumptive

Note: The ER value is dependent on the selected control. Multiple options may be available on this pump, as follows:

- Full Speed
- Pressure (Rated)

Power savings (watts) over a baseline case can be estimated by multiplying the ER by WAIP and multiplying by 7.46. Multiplying power savings by operating hours and cost of energy will yield estimated cost savings.

Q1PX2X er.pumps.org Apr 2021



Taco Inc., 1160 Cranston Street, Cranston, RI 02920 / (401) 942-8000 / Fax (401) 942-2360
Taco (Canada) Ltd., 8450 Lawson Road, Unit #3, Milton, Ontario L9T 0J8 / (905) 564-9422 / Fax (905) 564-9436